

B&C_o

outdoor dining & hydration



B&Co Smokeless BBQ Grill

The B&Co smokeless AI Fresco grill is the next innovation in charcoal cooking. Ready to start cooking for up to 6 people in under five minutes, the grill offers all the taste and flavour of traditional charcoal BBQ cooking without the timely set-up.



Zipped storage bag

FEATURES:

- Needs no electricity or gas
- Ready to cook in under 5 minutes (up to 30 minutes for traditional charcoal BBQ's)
- 250g of charcoal offers 40-100+ minutes cooking time (using up to 85% less charcoal than conventional BBQ's)
- Battery or USB operated airflow system, giving control of the heat intensity
- Cast iron 'skillet' style grill plate, offering great heat retention and easy clean
- The stainless steel drip tray is easy to clean due to the removable grill plate charcoal chamber and ignition plate
- Dishwasher safe
- Supplied with its own carry bag for easy storage

White	Slate Grey
653014	653015
5 035288 156502 >	5 035288 156519 >

Outer Qty: 4

Squeeze Bottle Lighter Gel

An eco-friendly, clean lighting fuel for the B&Co Smokeless grill. Simply squeeze the gel in to the ignition tray and light with a match or lighter. Place the charcoal chamber over the lit gel, turn up the fan on the grill to fully ignite the charcoal and you're ready to start cooking in under 5 minutes!

- Squeeze Bottle Lighter Gel
- For use with the B&Co Smokeless BBQ Grill (653014 & 653015)
- Non toxic, eco-friendly and odourless
- Provides a long, clean burn
- No need for electricity or gas
- Childproof cap
- Capacity: 250ml

652019



5 035288 140099 >

Inner Qty: 6 / Outer Qty: 48



Replacement Coal Bucket

653016



5 035288 157981 >

Outer Qty: 10



3 Piece BBQ Tool Set

The 3 piece B&Co BBQ utensil set is perfect for al fresco dining. The set contains a pair of stainless steel tongs, fish slice and fork - the perfect barbeque cooking tools. The durable carry case provides internal strap features to hold utensils safely during transportation and storage.

- Packaging: Sleeve
- BBQ tool set
- Stainless steel
- Includes tongs, spatula and fork
- 34,5cm / 13.6" length
- With carry case

650005



5 035288 138805 >

Inner Qty: 6 / Outer Qty: 48



Family Non Stick Gas BBQ

This portable Gas Barbecue Grill from B&CO is the next innovation in convenient, efficient outdoor dining. Providing instant, easy cooking with an electronic ignition system and variable heat control that allows you to cook food to perfection. The grill operates with 220g butane gas cartridges* (sold separately) and does not require coal for eco-friendly cooking.

*This gas stove should only be used with butane gas cartridges compliant with BSEN417.

- Packaging: Colour Box
- Smokeless outdoor barbecue grill
- Electronic ignition
- Gas powered provides instant cooking with variable heat control
- No messy coals of charcoal to clean up
- Aluminium with non-stick cooking surface
- Easy clean slide out drip tray

651042



5 035288 158216 >

Outer Qty: 5





Waterproof Blanket

This family sized jumbo waterproof picnic rug is perfect for family outings, the beach and for camping trips. The handy elastic compression straps are designed to help keep the rug compact when not in use.

- Packaging: Printed Label
- Packaging: Sleeve
- Picnic rug
- With waterproof back
- Elastic compression straps for compact storage
- Family size: 150 x 120cm / 59 x 47"

602000



Outer Qty: 12



Picnic Blanket/Cushion

An innovative picnic blanket that doubles as a seat cushion when zipped up. A fantastic product from B&Co to ensure you stay comfortable on your day out.

- Use as a picnic blanket or cushion
- Dimensions: 150 x 120 cm when opened
- Folds up into a bag when not in use
- Small accessories pocket
- Fleece front and water resistant back
- Shoulder strap
- Great for days out

602009



Inner Qty: 6 / Outer Qty: 24



MINI SILICONE TURNER AND TONGS SET

Ideal for a variety of cooking tasks including turning sausages and other meat in high temperature oil, mixing, stirring, cooking and flipping. Made from stainless steel and silicone.

- Packaging: Tie on card
- Stainless steel and silicone

671012



Inner Qty: 12
Outer Qty: 72



WAITERS FRIEND CORKSCREW BOTTLE OPENER

It is compact and easy to store in a drawer, picnic basket, or your pocket.

- Packaging: Tie on card
- Stainless steel
- Laser etched logo on the side

661019



Inner Qty: 24
Outer Qty: 72



16PC FAMILY CUTLERY SET

Set contains 4 forks, 4 spoons, 4 knives, 4 tea spoons. Made of high-quality stainless steel and featuring plastic handles, this cutlery set is perfect for everyday use.

- Packaging: Window box
- Stainless steel with plastic handles

662019



Inner Qty: 6
Outer Qty: 24



750ml Tritan Tracker

Stay hydrated with our 750ml Tracker Water Bottle. With a measuring guide to ensure you get your daily intake of water. The indented comfort grips make one handed use simple and the flip top straw makes for easy drinking on the go. It is a great alternative to single use plastic bottles as it's made from BPA free non toxic Tritan plastic. Great to use anytime, anywhere!

- Capacity: 750ml
- Guide in millilitres to track your water intake
- Flip top straw for easy drinking
- Handy hanging/carrying hook
- Indented comfort grips
- 4 Assorted colours: blue, berry, black and white

4 Assorted colours

696052



Inner Qty: 8 / Outer Qty: 48

Rubberised Bullet Flask

This bullet flask has a sleek matt rubberised finish. Made from high grade stainless steel with a double walled design that retains the temperature of liquids, keeping drinks hotter or colder for longer. It has a leakproof lid with press lock, and the lid can also be used as a cup - ideal for everyday commuting or longer journeys. Keeps drinks hot or perfectly chilled for up to 20 hours.

- Available in 750ml or 1 litre capacity
- Double walled stainless steel construction
- For hot or cold beverages
- Rubberised body that stays cool to touch
- Leakproof and condensation free
- An ideal gift

750ml Bullet Flask

Black	Grey
694117	694116

1L Bullet Flask

Black	Grey
694115	694114

Inner Qty: 6 / Outer Qty: 24



B&Co **CONICAL**
BOTTLE COLLECTION



Conical Bottle Collection

The reusable B&Co Conical bottles are made from high-grade stainless steel and feature an innovative double walled thermal construction that greatly improves its thermal properties compared to older style thermal flasks. These cone shaped bottles keep drinks hot for 12 hours and cold for 18 hours. Made from BPA-free materials, they offer a sustainable alternative to single-use plastic drinks bottles and cups.

- Capacity: 450ml
- Double wall stainless steel construction
- Thermal insulation keeps drinks hot for 12 hours or cold for 18 hours
- Leak proof lid with carry strap
- Soft touch, rubberised, matte exterior
- BPA free and condensation free
- Hand wash only

Blush Pink	Apple Green	Duck Egg	Dark Violet	Bold Blue	Coral	Rose Gold
694095	694090	694094	694101	694099	694100	694103



Honeycomb Bottle Collection

These bottles have a unique 3D honeycomb exterior which sets it apart from most drinks bottles, making it a unique gift.

Made from high quality stainless steel, with an innovative double walled thermal construction which keeps drinks hot for 12 hours and cold for 18 hours.

- Available in 350ml or 500ml litre capacity
- Double walled stainless steel construction
- For hot or cold beverages
- Unique honeycomb exterior that stays cool to touch and free from condensation
- Leakproof lid
- BPA free and condensation free
- Hand wash only
- An ideal gift

350ml Bottle

Copper	White
694105	694104
	

500ml Bottle

Copper	White
694107	694106
	

Inner Qty: 6 / Outer Qty: 36



AN IDEAL GIFT



Laser engraved logo on lid.





PANTONE® ROSE GOLD



SUSTAINABLE

This BPA-free bottle is an eco-friendly alternative to single-use plastic bottles.



WIDE MOUTH

Fits ice cubes to keep drinks chilled for even longer!



LEAK-PROOF

Airtight screw top lid with inner rubber seal prevents leaks and accidental spills.



PANTONE® SILVER



THERMAL INSULATION

Keeps drinks cold up to 18hrs and hot up to 12hrs.



CONDENSATION FREE

Exterior will remain dry and free from condensation, whether your drink is hot or cold.



DOUBLE WALLED

Vacuum insulated, high grade stainless steel.

500ml Thermal Bottle

A stylish drinks bottle with rose gold or silver mirrored finish. Ideal for travel, this bottle features a double walled thermal design that keeps drinks hot or cold while on the go. No need to worry about accidental spills with its leakproof lid and weighted base that prevents tipping.

- Capacity 500ml
- Double wall stainless steel construction
- Thermal insulated to keep drinks hot for 12 hours and cold for 18 hours
- Leak proof lid with laser engraved logo
- Wide mouth bottle fits ice cubes
- Weighted base prevents tipping
- BPA free and condensation free
- Hand wash only

Rose Gold

694078



Silver

694080



B&Co METALLIC BOTTLE COLLECTION



SUSTAINABLE

This BPA-free bottle is an eco-friendly alternative to single-use plastic bottles.



LEAK-PROOF

Airtight screw top lid with inner rubber seal prevents leaks and accidental spills.



DOUBLE WALLED

Vacuum insulated, high grade stainless steel.



CONDENSATION FREE

Exterior will remain dry and free from condensation, whether your drink is hot or cold.

WIDE MOUTH

Fits ice cubes to keep drinks chilled for even longer!



THERMAL INSULATION

Keeps drinks cold up to 18hrs and hot up to 12hrs.

Metallic Bottle Collection

Stay hydrated at home, at work or on the go with these stylish B&Co METALLIC bottles. Made from high quality stainless steel, designed with an innovative double walled thermal construction that greatly improves thermal retention when filled with hot and cold drinks. A reusable alternative to single-use plastic drinks bottles.

- Available in 350ml or 500ml capacity
- Double wall stainless steel construction
- Thermal insulation keeps drinks hot for 12 hours or cold for 18 hours
- Metallic exterior
- BPA free and condensation free
- Hand wash only

350ml Bottle			500ml Bottle		
Gold	Berry	Blue	Gold	Berry	Blue
694092	694091	694093	694098	694097	694096

REFILL
NOT LANDFILL

The UK fails to recycle 16 million single-use bottles everyday.

Plastic bottles and disposable coffee cups litter our streets and oceans. The "Refill. Not Landfill" campaign helps consumers become more aware of the impact single-use plastics have on the environment and our oceans, and encourages them to invest in reusable, sustainable alternative.



outdoor catalogue

SAVE SPACE WITH POP!

Our collapsible housewares range, designed to save valuable storage space, whether travelling or at home.

ENJOY THE OUTDOORS

Discover our full outdoor range of products, from outdoor dining, to family camping and solo trekking.





 Pantone Green 369
 Pantone Cool Grey 11C

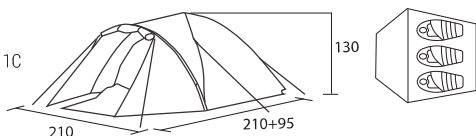

PINNACLE 3 DOME TENT



The Pinnacle 3 dome tent sleeps three people comfortably. The tent has back and side vents, a separate bedroom area, and a front porch area with barrier system to prevent running rain water from entering the tent.

- 3 Berth
- Dimensions: (L) 305 x (D) 210 x (H) 130cm
- 3000mm Hydrostatic Head
- Waterproof, fire retardant fabric
- Fully taped seams
- Sewn in groundsheet
- Front porch with barrier system
- Mesh door divides bedroom from porch area
- Zipped outer door
- Includes tent poles and ground pegs
- Includes storage bag

5710443	 5 035288 134098 >
Outer Qty: 4	

PINNACLE 4 DOME TENT



The Pinnacle 4 dome tent sleeps four people comfortably. The tent has back and side vents, a separate bedroom area, and a front porch area with barrier system to prevent running rain water from entering the tent.

- 4 Berth
- Dimensions: (L) 310 x (D) 270 x (H) 140cm
- 3000mm Hydrostatic Head
- Waterproof, fire retardant fabric
- Fully taped seams
- Sewn in groundsheet
- Front porch with barrier system
- Mesh door divides bedroom from porch area
- Zipped outer door
- Includes tent poles and ground pegs
- Includes storage bag

5710444	 5 035288 134128 >
Outer Qty: 2	



 Pantone Green 369
 Pantone Cool Grey 11C

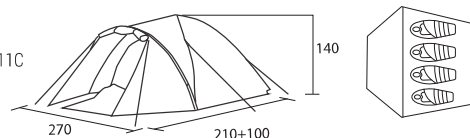

WHEN TAKING DOWN YOUR TENT...

- GIVE AIR AN ESCAPE ROUTE**
 Open doors and windows to allow air to escape as the tent is collapsed, this will make rolling and storing easier.
- REMOVE POLES**
 When collapsing sock-corded poles, start near the center to ease the stress on the cord. Push the pole through the pole sleeve, don't pull the poles as this can tear the shock-cord or the tent body.
- FOLD YOUR TENT**
 Fold the tent along its original fold lines. Alternatively, use the length of the tent poles as a guide when folding the tent, they should be the same length before rolling the tent.
- STORE YOUR TENT**
 Place your poles and stakes (in their bags) on the tent body - this will give the tent structure to roll. Slowly and tightly roll the tent so it is compact to fit easily into the storage bag. Store in a cool, dry place.



-  Forest Green
Pantone Green 5253
-  Indigo Blue
Pantone Blue 2168

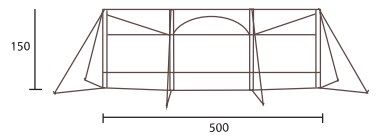

WIND BREAK



SHELTER



RETARDANT

A three panel, four pole wind screen that operates as a sturdy standalone shelter on a campsite or beach. Supplied with guy lines and steel pegs, it can be easily secured to the ground to offer much needed protection from the elements. It also comes with a storage bag for easy transportation.

- Packaging: Hang tag
- 3 Panel windbreak with windows
- Dimensions: 150 x 500cm
- 190T PU Polyester
- 4 Re-enforced poles
- 3 transparent windows
- Includes 6x two meter hi-vis guy ropes and 6x 6 inch steel pegs
- Includes storage bag

FOREST GREEN	INDIGO BLUE
570000	570001
 5 035288 156489 >	 5 035288 156472 >
Outer Qty: 10	



5 PANEL WIND BREAK

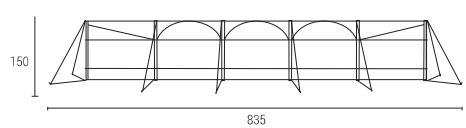
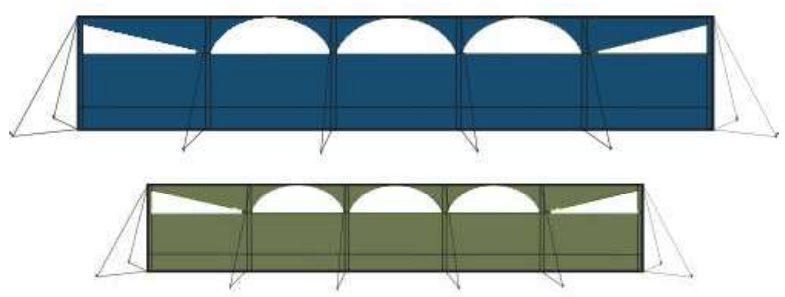

A five panel, four pole wind screen that operates as a sturdy standalone shelter on a campsite or beach. Supplied with high visibility guy lines and steel pegs, it can be easily secured to the ground to offer much needed protection from the elements. It also comes with a storage bag for easy transportation.

- Packaging: Hang tag
- 5 Panel windbreak with windows
- Dimensions: 150 x 835cm
- 190T PU Polyester
- 6 Re-enforced poles
- 5 transparent windows
- Includes 8x hi-vis guy ropes and 8x 6 inch steel pegs
- Includes storage bag



FOREST GREEN	INDIGO BLUE
572004	572003
 5 035288 158452 >	 5 035288 158445 >
Outer Qty: 10	

PACK OF 10



CORKSCREW PEGS

- Packaging: Poly Bag W/Header
- Steel tent pegs
- Pack of 10
- 18cm/7" long
- Suitable for hard terrain
- Steel with a virtual close head
- Ideal for securing tent guy lines

090/566



Inner Qty: 12
Outer Qty: 96

5 035288 099540 >

PACK OF 20

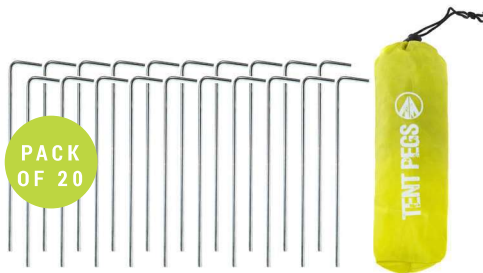

METAL TENT PEGS

- Packaging: Tie on card
- Steel tent pegs
- Pack of 20
- 18cm/7" long
- Supplied with waterproof storage bag

581007



Inner Qty: 6
Outer Qty: 60

5 035288 109430 >

PACK OF 4



STEEL HOOK PIN PEG

- Packaging: Poly Bag W/Header
- Steel tent pegs
- Pack of 4
- 23cm/9" long x 6mm diameter
- Bevelled end to go in ground
- Compatible with most tents

581007



Inner Qty: 24
Outer Qty: 72

5 035288 103230 >

PACK OF 4



7" ROCK PEGS

- Packaging: Poly Bag W/Header
- Steel tent pegs with glow in the dark head
- Pack of 4
- 18cm/7" long
- Ideal for larger tents & hard ground

581003



Inner Qty: 6
Outer Qty: 96

5 035288 105159 >

PACK OF 6



UTILITY PEG

- Packaging: Poly Bag W/Header
- Hook and eye tent pegs
- Pack of 6
- 21.5cm/8.5" long
- Ideal for larger tents and additional support
- Colour: yellow

581005



Inner Qty: 12
Outer Qty: 96

5 035288 105173 >

PACK OF 6



GLOW IN THE DARK UTILITY PEGS

- Packaging: Poly Bag W/Header
- Hook and eye tent pegs
- Pack of 6
- 21.5cm/8.5" long
- Glow in the dark

581018



Inner Qty: 12
Outer Qty: 96

5 035288 156038 >



TENT ACCESSORIES SET

- Packaging: Shelf Display Tray
- Packaging: Colour Box
- Rubber mallet with wooden handle
- 6 x 9" stainless steel tent pegs
- 4 x 5m guy ropes with tensioners
- Peg extractor

090/212



Inner Qty: 6
Outer Qty: 18

5 035288 105173 >



RUBBER Mallet

- Packaging: Wrap around card
- Packaging: Carded, Blister Card
- 12oz mallet with steel shaft
- Rubber handle for maximum grip
- Essential tool for setting up tents & gazebos

090/249



Inner Qty: 6
Outer Qty: 36

5 035288 094002 >



TENT PEG EXTRACTOR

- Packaging: Tie card
- Helps extract pegs from the ground
- Moulded ergonomic head
- Durable construction
- Additional leverage

581000



Inner Qty: 6
Outer Qty: 96

5 035288 103209 >



TWIN PACK

BUNGEE CORD TWIN PACK

- Packaging: Clip Strip
- Packaging: Poly Bag W/Header
- Pack of 2 bungee cords
- Secures items to trolley
- Heavy duty safety hook
- Rubber protectors on end of each hook
- 80cm Length
- Extends to 1 metre when in use

090/475



Inner Qty: 12
Outer Qty: 72



HI VIS GUY ROPES

These tent guy ropes can be used for spares or repairs. The high visibility guy ropes with reflective markings minimise the risk of accidents at campsites, particularly in the dark. Each pack includes glow in the dark tensioners for stability in rough weather.

- Packaging: Tie on Card
- High visibility Guy ropes
- Each 3.8m in length
- Pack of 4
- Each rope comes with glow in the dark tensioners

090/327



Inner Qty: 6
Outer Qty: 36



PACK OF 4

NYLON REPAIR PATCHES

The Summit self-adhesive nylon repair patches are ideal for repairing all manner of things from tents to jackets. The patches are made out of a tough ripstop material and each pack contains 4 coloured patches.

- Packaging: Header Card
- Self-adhesive Patches
- Instant repairs to tents and sleeping bags
- Strong and durable ripstop material
- Pack of 4; blue, cream, tan and green

090/590



Inner Qty: 24
Outer Qty: 144



SHOCK CORD KIT

The Summit Shock Cord repair kit contains everything you need to replace damaged shock cords in your tent poles. The repair kit includes an elasticated cord, metal wires and metal washers. This is a must have for camping trips.

- Packaging: Header Card
- Shock cord repair kit
- 12.95m elasticated cord
- 78cm metal cord
- 6x 8cm metal washers

583001



Inner Qty: 12
Outer Qty: 72

HEAVY DUTY TROLLEY KIT

A heavy duty, powder coated steel frame trolley, that folds flat, making it easy to both transport and store when not in use. The frame unfolds and when the locking gear is in place, it is ready to carry loads up to 50kg. To help keep your load in place a bungee cord is supplied with the trolley. A foam cushioned grip is attached to the top bar for comfort. The oversized rubber coated wheels are strong enough to help move loads on uneven ground.

- Loads up to 50kg
- Powder coated steel frame
- Foam cushioned handle
- Folding frame lock
- Oversized wheels for uneven ground
- Folds flat to save space and easy to store
- Includes bungee cord
- Weight: 2.3kg

808000

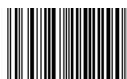



 Grass Green
 Pantone 369
 Cobalt Blue
 Pantone 2728

ENVELOPE THERMA SLEEPING BAG

 CORE	 2-3 SEASON	 WEIGHS 1KG	UPPER 11°C LIMIT	COMFORT 7°C	LOWER 0°C LIMIT
--	---	--	-------------------------------	-----------------------	------------------------------

The Summit Envelope Therma Sleeping Bag is fully insulated, lightweight, and durable. The sleeping bag is insulated with hollow fibre which will keep the individual warm while they sleep. The sleeping bag comes with its own draw string carry bag making it easy to transport and store away. This item is perfect for camping trips and overnight stays

- Rectangular sleeping bag
- 2/3 Season rating
- Integrated "S" shaped stitching
- Shell: 190T 100% polyester
- 250gsm hollow fibre filling
- Dimensions: 185cm(H) x 75cm(W)
- Storage bag included

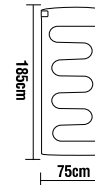

GRASS GREEN	COBALT BLUE
611019	611020
	
5 035288 130830 >	5 035288 130847 >
Inner Qty: 5 / Outer Qty: 10	



JUNIOR ENVELOPE THERMA SLEEPING BAG

 CORE	 2-3 SEASON	 WEIGHS 700G	UPPER 15°C LIMIT	COMFORT 11°C	LOWER 4°C LIMIT
--	--	---	-------------------------------	------------------------	------------------------------

This Summit junior sleeping bag is fully insulated, lightweight and durable. The sleeping bag has a cowl design to ensure maximum comfort when sleeping.

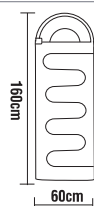
- Cowl sleeping bag
- Junior size
- 2/3 Season rating
- Integrated "S" shaped stitching
- Integrated hood
- 250gsm hollow fibre filling
- Dimensions: 160cm(H) x 60cm(W)
- Storage bag included



GRASS GREEN	COBALT BLUE
611059G	611059B
	
5 035288 147821 >	5 035288 147838 >
Inner Qty: 2 / Outer Qty: 10	



INSULATED FOAM MAT

Designed with an insulated underlayer to prevent campers from losing heat while on cold or damp floor, maintaining a level of comfort. It is ultra compact and lightweight to for convenience.

- Packaging: Shelf Display Tray
- 6 Pieces per display unit
- Dimensions: 180 x 50 x 0.5mm
- Insulated mat provides extra comfort when sleeping on the ground
- EVA foam with aluminium foil backing
- Elasticated straps for compact storage

613002	
Inner Qty: 6	

FOAM MAT

This camping mat is ideal for use underneath a sleeping bag inside a tent, or for extra comfort on a camping bed. The insulated design ensures the chill won't creep through and disturb your sleep.

- Blue camping mat
- 2 x elastic wrap straps
- Dimensions: 180 x 50 x 0.5mm
- Elasticated straps for compact storage



613001	
Outer Qty: 15	



SINGLE



DOUBLE

INFLATABLE FLOCKED AIR BED	
<p>This luxury single air bed mattress is constructed from a lightweight and durable PVC to withstand rough surfaces. The air bed features a soft-touch flocked topside for maximum heat retention, and to ensure a comfortable night's sleep. This item is ideal for camping trips, festivals and to have as a spare bed at home.</p>	
<ul style="list-style-type: none"> • Packaging: Colour Box • Luxury inflatable mattress • Soft flocked top side • Easy to inflate • Single Dimensions: 191 x 73 x 22cm • Double Dimensions: 191 x 137 x 22cm • Packs down for storage • Durable PVC material 	
SINGLE	DOUBLE
616001	616000
 <p>5 035288 107108 ></p>	 <p>5 035288 107085 ></p>
Inner Qty: 6 / Outer Qty: 12	Inner Qty: 4 / Outer Qty: 8



12V MAINS & BATTERY POWER AIR PUMP	
<p>This Summit 12V high powered PSI battery operated air pump outputs of up to 200L per minute or 0.38psi. The pump comes with three additional nozzles which can be used for inflation/deflation on a wide range of inflatables and air beds. The pump works with either the main power supply or batteries.</p>	
<ul style="list-style-type: none"> • Packaging: Colour Box • Battery Information: 8 x AA (not included) • 12V two way air pump • Operates via battery or 12V DC adapter • Includes 3 additional nozzles • Includes 12V car adapter • Outputs 200L/min or 0.38 PSI • 5 minutes maximum continuous use 	
616003	 <p>5 035288 130977 ></p>
Inner Qty: 6 Outer Qty: 24	



6V BATTERY POWERED AIR PUMP	
<p>High PSI (pounds per square inch) battery operated air pump which outputs up to 350L per minute or 0.48psi. The pump includes three additional nozzles for use on a wide range of inflatables such as airbeds, inflatable pools and beach inflatables.</p>	
<ul style="list-style-type: none"> • Packaging: Colour Box • Battery Information: 4 x D (not included) • 6V air pump • Battery operated • Includes 3 additional nozzles for inflation • Outputs 350L/min or 0.48 PSI • 5 minutes maximum continuous use 	
090/332	 <p>5 035288 095566 ></p>
Inner Qty: 6 Outer Qty: 24	



3L BELLOWS FOOTPUMP	
<p>This foot pump is lightweight and portable - ideal festivals and camping. It's compact size fits most backpacks, car boots and cupboards. It has a flexible hoze and comes with various nozzle attachments to fit most airbeds and other inflatables.</p>	
<ul style="list-style-type: none"> • Packaging: Colour Box • High volume airflow • Capacity: 3 Litre • Compact size • Inflate/deflate function • Detachable flexi hose • 3 alternative universal fittings supplied 	
616007	 <p>5 035288 141065 ></p>
Inner Qty: 6 Outer Qty: 24	

2L DOUBLE ACTION HAND PUMP	
<p>Inflate your airbeds, inflatable pools and beach inflatables quickly and efficiently with this double action hand pump. Simply pump the handle up and down while standing on the foot supports for continuous air flow and inflation. Inflates twice as fast as normal pumps. Supplied with multi-use adapters and can also be used for easy deflation.</p>	
<ul style="list-style-type: none"> • Packaging: Colour Box • Double action hand pump • Capacity: 2 X 2,000ccm • Easily inflates and deflates • Includes 3 valve adapters (universal fittings) • Footplate for ease of use • Length of hose: 1.20m 	
616004	 <p>5 035288 144080 ></p>
Inner Qty: 6 Outer Qty: 12	





BERKLEY PADDED FOLDING CHAIR



The Summit Padded Relaxer Chair is great for camping, festivals, fishing or just relaxing in the garden. It has a lightweight frame and comfortable padded seating. It features a handy drinks holder on the arm rest and can be folded and stored compactly in its own carry bag for easy transportation.

- Packaging: Hang tag
- Fabric: 600D polyester
- High back with padding for added comfort
- Opens Dimensions: 106(H) x 101(W) x 60cm(D)
- Packed Dimensions: 102(H) x 24(W) x 24cm(D)
- Maximum load 110kgs
- Powder coated folding frame
- Cup holder on one arm
- Storage bag included

FOREST GREEN	INDIGO BLUE	SLATE GREY
633109	633110	633111
Outer Qty: 4		



ORCA FOLDING CHAIR



The Orca chair is padded for maximum comfort and luxury. They are perfect for camping but also for use in the garden or on picnics. The innovative "Bucket Style" combines a high level of comfort and support. The chair comes with its own carry bag for easy transportation.

- Packaging: Hang tag
- Fabric: 600D polyester
- Open Dimensions: 80(H) x 85(W) x 63cm(D)
- Packed Dimensions: 85(H) x 22(W) x 25cm(D)
- Maximum load 120kgs
- Powder coated folding frame
- Bucket style chair
- Storage bag included

FOREST GREEN	INDIGO BLUE	SLATE GREY
633112	633114	633113
Outer Qty: 6		



DIRECTOR'S CHAIR



The Summit Director's Chair with integral folding table and drinks holder is extremely lightweight and the strong frame offers maximum support. It also folds easily for storage and transportation. Our chairs are ideal for use in your garden, while camping or general outdoor use.

- Packaging: Hang tag
- Fabric: 600D polyester
- Open Dimensions: 79(H) x 56(W) x 49cm(D)
- Packed Dimensions: 79(H) x 14(W) x 49cm(D)
- Powder coated folding frame
- Padded arm rest covers
- Folding table with cup holder
- Maximum load 120kgs
- Lightweight Aluminium Frame

FOREST GREEN	INDIGO BLUE	SLATE GREY
633121	633120	633097

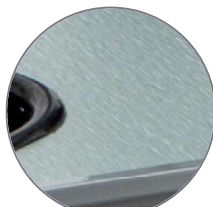

FOLDING TABLE IN BRUSHED METAL FINISH WITH INSULATED CUP HOLDER



WEIGHS A MERE 1KG!



ULTRA LIGHT PACK AWAY CHAIR

LIGHT WEIGHT	ULTRA COMPACT	WATER RESISTANT	LOAD CAPACITY 110kg	PACKED WEIGHT 1.1kg	QUICK ASSEMBLY	COOLING MESH
---------------------	----------------------	------------------------	----------------------------	----------------------------	-----------------------	---------------------

The Summit Pack Away Chair showcases an innovative design that allows it to collapse down to a tenth of the size of conventional folding chairs. When packed into its own storage bag, it's small enough to fit in most backpacks and weighs just 1kg - the same as a bag of sugar! This chair is an essential piece of equipment for travellers, campers and trekkers alike.

- Packaging: Hang tag
- Fabric: 600D x 300D Oxford polyester
- Open dimensions: 59cm(H) x 50cm(W) x 64cm(D)
- Packed dimensions: 14cm(H) x 36cm(W) x 12cm(D)
- Chair weighs just 1kg!
- Pre-attached connectors for quick assembly
- Ready to use in under 30 seconds
- Water resistant - easy to clean
- Includes storage bag with shoulder strap

FOREST GREEN	INDIGO BLUE	SLATE GREY
633115	633116	633117
5 035288 153761 >	5 035288 153778 >	5 035288 153785 >
Inner Qty: 4 / Outer Qty: 12		

HIGH BACK PACK AWAY CHAIR

LIGHT WEIGHT	ULTRA COMPACT	WATER RESISTANT	LOAD CAPACITY 120kg	QUICK ASSEMBLY	COOLING MESH	BUILT-IN PILLOW
---------------------	----------------------	------------------------	----------------------------	-----------------------	---------------------	------------------------

HIGH BACK & PADDED HEADREST

The Summit High Back Pack Away Chair showcases an innovative design that allows it to collapse down to a fraction of the size of a conventional folding chair. When packed into its own storage bag, it's small enough to fit in most backpacks and weighs under 2kg! The high back rest has a built in pillow for extra comfort. An essential piece of equipment for travellers, campers and trekkers alike.

- Packaging: Hang tag
- Fabric: 600D x 300D Oxford polyester
- Open dimensions: 59cm(H) x 58cm(W) x 60cm(D)
- Packed dimensions: 15.5cm(H) x 42cm(W) x 13.5cm(D)
- Chair weighs under 2kg!
- Pre-attached connectors for quick assembly
- Ready to use in under 30 seconds
- Water resistant - easy to clean
- Includes storage bag with shoulder strap

FOREST GREEN	INDIGO BLUE	SLATE GREY
633118	633099	633119
5 035288 153488 >	5 035288 143557 >	5 035288 153495 >
Outer Qty: 8		





**ESSENTIALS
THAT EVERY FESTIVAL-GOER NEEDS
TO MAKE THEIR EXPERIENCE
FUN AND STRESS-FREE.**

**POP UP TENT
HAS A FLEXIBLE FRAME
THAT INSTANTLY SPRINGS INTO SHAPE
WHEN REMOVED FROM STORAGE CASE.**



- Pantone Grass Green 369
Pantone Cool Grey 11C
- Pantone Violet 2602
Pantone Cool Grey 11C
- Pantone Royal Blue 2728
Pantone Cool Grey 11C

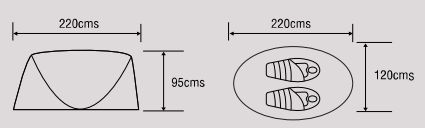

- Pantone Green 369
Pantone Cool Grey 11C
- Pantone Royal Blue 2728
Pantone Cool Grey 11C

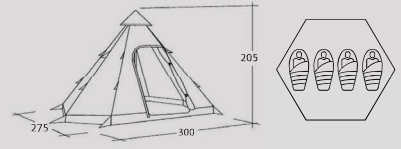

2 PERSON POP UP TENT



A compact, waterproof tent that is easily assembled in seconds. It comfortably sleeps two people and is the perfect product for hassle free camping. Supplied with its own storage bag.

- Packaging: Storage bag W/Print
- 2 Berth
- Dimensions: (L) 310 x (D) 270 x (H) 140cm
- 1500mm Hydrostatic Head
- Waterproof, fire retardant fabric
- Fully taped seams
- Two net storage pouches inside
- Rear vent
- Sewn in groundsheet
- Zipped outer door
- Inner door with mosquito mesh guard
- Includes 4x high-vis guy ropes & 6x tent pegs
- Includes storage bag

GRASS GREEN	VIOLET	ROYAL BLUE
571125	571124	571126

Outer Qty: 9

4 PERSON TIPI TENT



This four berth tipi tent features a hexagonal base and a single central pole for maximum stability. Comes with pre-attached guy ropes for effortless assembly.

- Packaging: Storage bag W/Print
- 4 Berth
- Dimensions: (L) 300 x (D) 275 x (H) 205cm
- 1500mm Hydrostatic Head
- Waterproof, fire retardant fabric
- Fully taped seams
- Hexagonal base
- Sewn in groundsheet
- Zipped outer door
- Includes 7x pre-attached guy ropes & 13x tent pegs
- Includes storage bag

GRASS GREEN	ROYAL BLUE
571046G	571046B

Outer Qty: 6



SUMMIT ONESIE SLEEPING BAG



TOGGLES TO
TIGHTEN HOOD FOR
EXTRA INSULATION.

COMES WITH ITS OWN
STORAGE BAG
FOR EASY TRAVEL



ZIP CLOSURE
ALLOWS YOU TO
FREE YOUR HANDS WHEN REQUIRED.
KEEPS HANDS OUT OF THE COLD.



ZIP-OFF FEET FOR EASY
CLEANING & MOVEMENT.

SIZE	DIMENSIONS
Kids	Height: 135cm Chest: 58cm
Medium	Height: 175cm Chest: 65cm
Large	Height: 200cm Chest: 65cm

ONESIE SLEEPING BAG



WEEKENDER



2-3 SEASON



8°C
COMFORT



3°C
LOWER
LIMIT



-5°C
EXTREME
LIMIT

- Packaging: Printed Insert
- Medium size: 175 x 65cm / 69 x 26" approx
- Large size: 190 x 65cm/75 x 26" approx
- Kids size: 135 x 58cm
- Fits up to 180cm height
- 190T Polyester outer
- 170T Polyester inner lining
- 250gms micro hollow fibre filling
- Child safe toggle
- Zips to unfasten hands and remove foot sections
- Includes storage bag

FEATHERLIGHT ONESIE SLEEPING BAG



WEEKENDER



1-2 SEASON



LIGHTWEIGHT



18°C
UPPER
LIMIT



12°C
COMFORT



5°C
LOWER
LIMIT



2°C
EXTREME
LOW

- Packaging: Printed Insert
- Medium size: 175 x 65cm / 69 x 26" approx
- Large size: 190 x 65cm/75 x 26" approx
- Fits up to 180cm height
- 190T Polyester outer
- 170T Polyester inner lining
- 100gms micro hollow fibre filling
- Child safe toggle
- Zips to unfasten hands and remove foot sections
- Includes storage bag

BLACK



(Medium) 611043

(Large) 611044

BLUE



(Medium) 611046

(Large) 611045

BLACK



(Medium) 611052

(Large) 611054

BERRY



(Medium) 611053

(Large) 611055

BLUE



(Kids) 611050

BERRY



(Kids) 611051

Outer Qty: 6



SOLAR SHOWER

This portable solar shower is beneficial to any camper or festival lover. The camp shower is capable of heating up to 40 degrees in just a matter of hours - simply fill with water and leave in sunlight. Includes a flexible tube and shower head with on/off control.

- Packaging: Colour Box
- Will heat up to 40C in 3 hours
- Ideal for beaches, camping and caravans
- 20L shower equals a 7 minute shower
- Solar heated

090/243	 5 035288 093883 >
Inner Qty: 6 Outer Qty: 36	

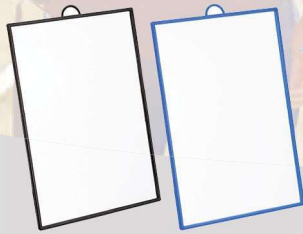

GLASS UTILITY MIRROR

A compact, lightweight mirror you can stand or hang. Comes in 2 assorted colours.

- Packaging: Carded, Blister Card
- Dimensions: 17 x 12cm
- Back leg for standing
- Hanging hook
- Plastic surround
- 2 Assorted colours; black and blue

740039	 5 035288 157790 >
Inner Qty: 12 Outer Qty: 72	



LIGHTWEIGHT PACK AWAY CAMP BED

Designed for outdoor enthusiasts, this folding bed is super lightweight, weighing under 5lbs! It has strong, stable aluminium legs and is made from a durable, water-resistant fabric for a dry nights sleep. It is super quick to set up and take down. It comes with its own compact storage bag, taking up minimal space when travelling.

- Packaging: Hang tag
- Dimensions: 190 X 70 X 17
- Material: 420D Polyester with waterproof PU coating
- 120kg Max load
- High-grade aluminum folding joints
- Quick to set up and easy to take down
- Anti-slip feet with structure for every surface
- Intergrated pillow
- Complete with storage bag

632011	
Outer Qty: 6	

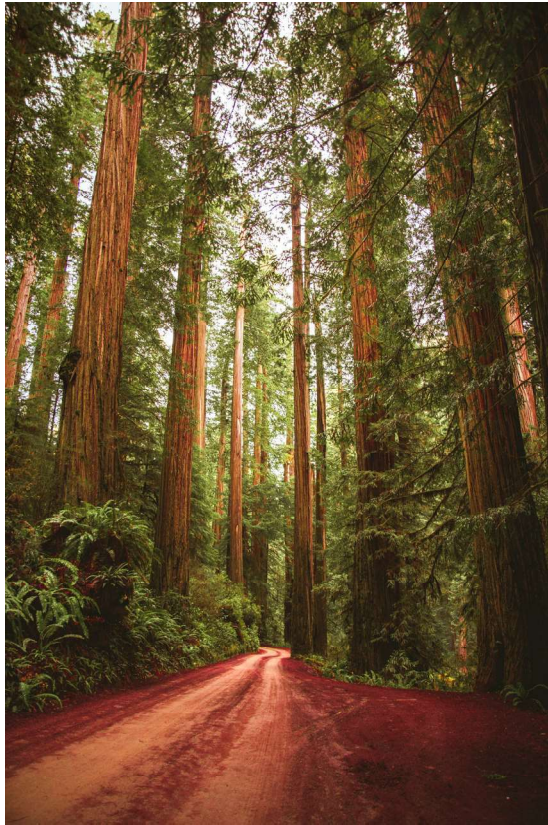

SELF INFLATING ANTI SLIP CAMPING PILLOW

Rest in comfort whether travelling or camping with this lightweight pillow from Summit. Easy to inflate and deflate with a twist valve. Complete with a compact stuff sack with shoulder strap for easy carrying.

- Packaging: Header Card
- 210T Rip stop polyester one side
- Soft brushed polyester other side
- Hollow fibre filling
- Pillow indent for head support
- Packs into its own storage bag
- Dimensions: 40 x 26 x 8cm

612008	
Outer Qty: 24	



PINNACLE COLLAPSIBLE BUG ZAPPER & LANTERN

This collapsible 2-in-1 LED lantern light and pop out ultra-violet bug zapper is the perfect companion for camping adventures, where mosquitos, midges and other insects are present. The lantern has three light settings that lasts up to 24 hours before it requires charging.

- Packaging: Window box
- 94mm (diameter) x 52mm (height)
- 2-in-1 LED lantern and insect repellent
- Zaps bugs attracted to the LED light
- Collapses into portable size
- Integral hanging hook
- 3 light modes: 100% (100 lumens), 50% (50 lumens), 25% (24 lumens)
- Working time: up to 24 hours
- Charging time: approx 3 hours
- Micro USB cable included

742024



Inner Qty: 6 / Outer Qty: 36

5 035288 157738 >

SILICONE POP UP LANTERN

This compact LED Lantern is great for outdoor adventures as it's compact size won't take up much storage space. It has three built-in light modes, and a retractable silicone globe that glows in the dark for up to 2 hours after exposure to light. It can be hung from your tent with the integral hanging hook that folds in to base when not in use.

- Packaging: Window box
- Contains 3 white SMD LEDs and 1 yellow SMD LED
- 3 Light modes: 50%, 100%, flickering light (imitating candle).
- Glow in the dark silicone globe that collapses in to base
- Ultra lightweight and portable
- Integrated hanging hook
- Battery requirements: 3 X AA (not included)

842059



Inner Qty: 24 / Outer Qty: 72

5 035288 157134 >



TREKKER'S FIRST AID KIT

The perfect companion for those who spend prolonged periods walking or hiking through woodland, heathland or forests. This first aid kit includes all the essentials for common injuries as well as a handy tick remover and emergency foil blanket, stored in a water-resistant bag.

- Packaging: Hang tag
- 2pc blister skins (44mm x 69mm)
- 10pc blister plasters
- 10pc regular plasters (72mm x 19mm)
- 4 x alcohol wipes
- 1 x woven bandage (50mm x 4metre)
- 1 x scissors (5cm blade)
- 5 x safety pins
- 1 x plastic tweezers
- 1 x tick remover
- 1 x micro tape roll (12.5mm x 5metre)
- 5 x 3ply gauze pads (75mm x 75mm)
- 1 pair vinyl gloves (white)
- 1 x emergency blanket (130cm x 210cm)

743013



Inner Qty: 6 / Outer Qty: 36

5 035288 153020 >



PINNACLE 1.6*2.1M EMERGENCY FOIL PONCHO

An essential piece of survival equipment for day trekkers, hikers and campers. This emergency poncho reflects body heat, even when wet, to help prevent shock and hypothermia. It is also effective at shielding you from wind and rain.

- Packaging: PVC bag
- Dimensions: 1,6 x 2,1 metres
- Ideal for emergency situations
- One size fits all
- Helps to retain body heat in emergency situations
- Waterproof and windproof

743016



Inner Qty: 12 / Outer Qty: 48

5 035288 157103 >



GP SX4 COMPASS

A scratch resistant compass featuring a practical lanyard for ease of access, a map scale of 1:25000 / 1:50000, and luminous dials for dusk visibility. This GP-SX4 Compass will help you find your way when map reading in the outdoors.

- Packaging: Window box
- Map scales 1:25000/ 1:50000
- Large magnifying lens
- Luminous dials for night-time visibility
- Measurements along side
- Direction of travel arrow
- Strong ABS construction
- Scratch resistant
- Complete with lanyard and instructions

767009



Inner Qty: 12 / Outer Qty: 48

5 035288 153006 >



Trekking Essentials

 Pinnacle Green
Pantone Green 5253

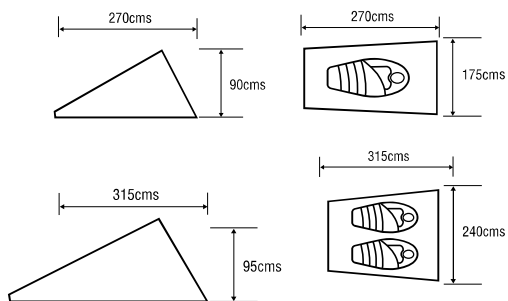

TREKKER TENT

 WEEKENDER	 SEWN IN GROUND SHEET	 RETARDANT	 2000MM	 TAPED	 DOUBLE SKIN	 1/2 BERTH
---	---	---	--	---	---	---

This tent has been designed with trekking in mind. It is great for the solo camper, fitting one person comfortably with luggage. A great weekender tent for camping and festivals. It features a built in groundsheet and PU coated flysheet for weather protection, plus anti mosquito mesh doors. Lightweight and compact and comes in its own carry bag.

- Packaging: Storage bag W/Print
- 1 or 2 berth tunnel tent
- Weighs approx 2kg
- Single Dimensions: (L) 270 x (D) 175 x (H) 90 cm
- Double Dimensions: (L) 315 x (D) 240 x (H) 95 cm
- Waterproof, fire retardant fabric
- Fully taped seams
- Sewn in groundsheet
- Zipped D-shaped outer door
- Inner door with mosquito mesh guard
- Includes guy ropes, poles and pegs
- Includes storage bag

Single	Double
571053	571054
	
5 035288 143779 >	5 035288 143755 >

Outer Qty: 6

LIGHTWEIGHT SLEEPING BAG DESIGNED TO TAKE UP MINIMAL SPACE



ULTRA LITE TREKKER SLEEPING BAG

 CORE	 1-2 SEASON	 WEIGHS 580G	 EXTREME 22°C MAX	 LOWER 14°C COMFORT	 EXTREME 10°C LIMIT	 2°C LOW
--	---	---	--	--	--	---

The Summit Ultralite sleeping bag is a great space saving option for any outdoor enthusiast looking to minimise the weight and size of their equipment. The Ultralite is soft to the touch and comes with a wind baffle to protect you from sudden changes in weather. The Ultralite also features an inside pocket to keep small valuables easily accessible. Perfect for light travel.

- Mummy style sleeping bag
- 1-2 Season rating
- Ultra lightweight - weighs under 1kg!
- 65g silk like filling
- 210T rip stop material
- Dimensions: 220 x 80cm / 87 x 31" approx
- Temperature: Upper 22 c / Comfort 14 c / lower 2 c
- Stuff sack included

611061	
Outer Qty: 18	
5 035288 147951 >	



ANTI SHOCK TREKKING POLE

The 3 section trekking pole extends up to 135cm. It is made from lightweight aluminium and features an anti-shock function, twist on/off. It also comes with tip protector and loose ground ferrule basket. Supplied in 3 assorted colours.

- Packaging: Tie on card
- 3 section adjustable trekking pole
- Anti-shock features - twists on or off
- Removable ferrules and snow baskets
- For soft and hard ground
- 3 Assorted colours: black, blue and red

761015



Inner Qty: 12 / Outer Qty: 36



REPLACEMENT FERRULES

- Packaging: Polybag
- Walking stick ferrules for trekking poles
- Pack of 2
- Colour: black

LWL000



Outer Qty: 200



GAITER

- Packaging: Hanging Card
- Set of 2 waterproof gaiters
- Taped seams
- Elasticated bottom
- Metal lace hooks under shoe cord
- Draw string on top section for secure fit
- Storage bag included

772000



Inner Qty: 12
Outer Qty: 36



TACTICAL 3W COB HEADLAMP

The tactical headlight is housed in a rubberised, weatherproof body and features glow in the dark buttons, an adjustable headstrap and the head light adjusts to direct the light efficiently. Cycle through the left button and you go through white mode, green mode for night time map reading and red mode for night vision. The right button gives you 100%, 50% floodlight focused beam function and flashing option.

- Packaging: Colour Box
- Battery Information: 3 x AAA not included
- Lumens: coloured COB 80, White COB 200, LED 150
- 8 hours illumination
- Floodlight 3W COB 25m range
- Focus 3W LED 80m range
- Multi-functional area illumination
- IP54 weatherproof
- Adjustable head strap for a comfortable fit
- Adjustable headlight angle to direct light efficiently

843022



Inner Qty: 4
Outer Qty: 48



BINOCULARS

Binoculars with an 8x magnifications, an object lens diameter of 21mm and a 7.20 angle view. Supplied with storage case.

- Packaging: Clam Pack
- Binoculars with PU leather storage case
- Compact and lightweight
- Precise focussing
- 8x magnification
- 21mm coated lenses
- Includes neck strap

762000



Inner Qty: 3 / Outer Qty: 48



380ML DOUBLE WALLED MUG

A double-walled insulated mug to keep hot drinks hot and cold drinks cold! Extremely effective, and with rubber for easy gripping, this is great for long journeys or camping trips.

- Packaging: Printed Label
- Capacity: 380ml
- Durable stainless steel construction
- Double walled thermal insulation
- Ideal for hot or cold drinks
- Non slip base
- Soft touch pourer
- 4 Assorted colours; purple, green, blue, red

663011



Inner Qty: 4 / Outer Qty: 48



750ML WATER BOTTLE

A durable aluminium water bottle with a stylish brushed metal finish. The screw lid comes with a colour coordinating carabiner so that you can attach it easily to your bag or back pack. With its 750ml capacity, this bottle is ideal for keeping you hydrated on any activity.

- Packaging: Hanging Card
- 750ml capacity
- Brushed metal finish
- Lightweight aluminium bottle
- Screw top lid
- Carabiner included
- 4 Assorted colours: red, blue, green, purple

695014



Inner Qty: 4
Outer Qty: 48



6OZ HIP FLASK

A great quality hip flask with a hinged screw cap lid to prevent loss of the lid. made from durable stainless steel with a polished finish and laser engraved branding. Makes an ideal gift!

- Packaging: Shelf Display Tray
- Packaging: Printed Label
- Capacity: 6oz
- Durable stainless steel construction
- Metal lid and attachment
- Polished finish
- An ideal gift

090/671



Inner Qty: 6 / Outer Qty: 48

8 IN 1 TOOL



8 IN 1 DINING TOOL

This spork has a large finger hole in the middle to keep the product lightweight. It has three metric wrench reliefs of 10mm, 8mm and 6mm for emergency repairs, and a bottle opener on one side. The carabiner allows easy attachment to bags or belt loops while travelling. Liang Mah's design has become an instant favourite among campers.

- Packaging: Clam Shell
- Multi function, space saving tool with carabiner
- Spork, bottle opener and wrench relief valves
- Made from stainless steel

662000



Inner Qty: 12 / Outer Qty: 48

QUATTRO SPACE SAVING CUTLERY SET

This ultimate space saving utensil combines a fork, spoon and serrated blade to meet the needs of the camper. Ideal for camping, hiking or fishing trips, this lightweight, hardwearing utensil is compact and saves space in the rucksack. It comes with a handy carabiner to securely fasten it to rucksacks etc.

- Packaging: Hang Card
- Space saving utensil
- Serrated blade, fork & spoon
- Carabiner
- Size: 150 x 37 x 2mm
- Food grade plastic
- 4 Assorted colours: red, blue, green, purple

662011



Inner Qty: 24 / Outer Qty: 72



STAINLESS STEEL PLATE & BOWL SET

A tough stainless steel plate and bowl set with high sides to make outdoor eating more comfortable. Easy to clean. Ideal for camping, hiking and travel.

- Packaging: Clam Shell
- Made from stainless steel
- 14.5cm diameter bowl
- 20cm diameter plate

SET347



Inner Qty: 6 / Outer Qty: 24

MESS TIN SET

Not only do they provide easy and efficient cooking when outdoors, this 2 piece set boasts a 1.1L & 1.3L capacity tin that conveniently packs into each other with added fold away handles for extra convenience when storing.

- Packaging: Shelf Display Tray
- Packaging: Poly/Plas Bag Single
- Aluminium
- 2 sizes; 1.3L & 1.1L
- Nesting mess tins
- Compact and lightweight
- Built in fold away handles

090/209



Inner Qty: 6 / Outer Qty: 36





INSULATED MUG WITH LID

This double wall insulated stainless steel mug is innovatively designed to prevent spills and burns. The carabiner handle is ideal for attaching to your belt or bag. The perfect accessory for any outdoor pursuits.

- Packaging: Printed Label
- Capacity: 300ml
- Carabiner handle
- Double wall stainless steel
- Sealing lid with drinking spout
- 4 Ssorted colours: red, blue, green and purple

090/569



Inner Qty: 8 / Outer Qty: 48

300ML STAINLESS STEEL MUG

Made from high grade stainless steel with a double walled construction to ensure your drink keeps its temperature for longer. It's durable design makes it perfect for outdoor adventures.

- Packaging: Printed Label
- Capacity: 300ml
- Carabiner handle
- Durable stainless steel construction
- Double walled thermal insulation
- Ideal for hot or cold drinks

663030



Inner Qty: 4 / Outer Qty: 48

450ML STAINLESS STEEL MUG

Made from high grade stainless steel with a double walled construction to ensure your drink keeps its temperature for longer. It's durable design makes it perfect for outdoor adventures.

- Packaging: Printed Label
- Capacity: 450ml
- Durable stainless steel construction
- Double walled thermal insulation
- Ideal for hot or cold drinks

663016



Inner Qty: 8 / Outer Qty: 48



300ML STAINLESS STEEL CARABINER MUG

This stylish and colourful mug has a handy carabiner handle, making it convenient for use on the go. Made from stainless steel, its durability is ideal for taking on a range of outdoor pursuits.

- Packaging: Printed label
- Capacity: 300ml
- Carabiner handle
- Durable stainless steel construction
- Double walled thermal insulation
- Ideal for hot or cold drinks

BLACK

BLUE

RED

663058

663057

663056



5 035288 156397 >

5 035288 148767 >

5 035288 148750 >



4 SLICE FOLDING TOASTER

An innovative design which allows the toaster to be folded into a compact size for easy transportation. When the toaster is securely placed over a camping stove food will be toasted quickly.

- Packaging: Colour Box
- Toasts up to 4 slices
- Place over camping stove to toast
- Folds up for compact storage
- Colour box packaging

675000



Inner Qty: 6 / Outer Qty: 48



FOLDING TOASTER

The Summit Folding Toaster is great for when camping, at festivals or fishing. Perfect for use on all camping cookers. Practical, simplistic and easy to use. Toasts one slice of bread at a time. Folds for compact storage.

- Packaging: Blister Card
- Folds for compact storage
- Ideal for camping
- Place over campfire or BBQ
- Toasts 1 slice at a time
- Durable metal design
- Folding handle
- Stainless Steel

675001



Inner Qty: 12 / Outer Qty: 72



WHISTLING KETTLE

Great for campers and fisherman who still enjoy their home comforts while on a trip, this classic stainless steel kettle has a 2L capacity and whistles when your water has boiled.

- Packaging: Colour Box
- Capacity: 2 litre
- Stainless steel kettle with lid
- Whistles when boiling
- Mirror polish finish
- Handle moves to one side

STAINLESS STEEL

3 ASSORTED COLOURS

090/266

090/270



Inner Qty: 6
Outer Qty: 12

Outer Qty: 12



SILICONE CLEANING PAD

The Summit reusable silicone effect cleaning pad with handy carabiner is non-abrasive so it never scratches. It's ideal for pots, pans and flexible enough for cleaning inside glasses, even for washing your fruit and veg. Use the pad to replace your old style cloth or brush to improve kitchen hygiene as it reduces drying time and is mildew resistant

- Packaging: Wrap around card
- Reusable silicone effect cleaning pad
- Reduces drying time for increased hygiene
- Bacteria and mildew resistant
- Bends and flexes to get inside corners & glasses
- Non-abrasive
- Safe to use on non-stick cookware

740038



Inner Qty: 8 / Outer Qty: 48



QUATTRO SPACE SAVING CUTLERY SET

This ultimate space saving utensil combines a fork, spoon and serrated blade to meet the needs of the camper. Ideal for camping, hiking or fishing trips, this lightweight, hardwearing utensil is compact and saves space in the rucksack. It comes with a handy carabiner to securely fasten it to rucksacks etc.

- Packaging: Hang Card
- Space saving utensil
- Serrated blade, fork & spoon
- Carabiner
- Size: 150 x 37 x 2mm
- Food grade plastic
- 4 Assorted colours: red, blue, green, purple

662011



Inner Qty: 24 / Outer Qty: 72



SILICONE TONGS

These heat resistant Silicone Tongs come with a metal clasp to keep them closed when not in use to help reduce the risk of damage. The tongs are perfect for camping trips and for the kitchen.

- Packaging: Header Card
- Heat resistant
- Metal clasp to keep closed when not in use
- Length: 18cm
- 2 Assorted colours: lime green and grey

672001



Inner Qty: 12 / Outer Qty: 72



WINE BOTTLE AND TWO WINE GLASS HOLDERS

Forget about spillages caused by placing a wine bottle and glasses on bumpy ground during picnics - the B&Co wine bottle and glass holders provide safe and stable place to keep them.

As well as featuring a decorative spiral design, these holders are made from durable stainless steel with spiked ends so they can be easily inserted into the ground wherever you are!

- Packaging: Carded, Blister Card
- Wine bottle holder complete with two wine glass holders
- Beautiful spiral design
- Durable stainless steel material
- With spiked bottom for inserting into the ground
- A picnic essential!
- Available in copper - item 660007

660000	
Inner Qty: 6 / Outer Qty: 24	



12.5L COOL BAG

Cool bag with a large 12.5 litre capacity and zip top closure. Ideal for taking packed lunches to day events or family picnics. Folds down compact for easy storage.

- Packaging: Polybag & Header card
- Capacity: 12.5 litres
- Holds up to 24 cans
- Insulated to keep food and drinks chilled
- Sturdy carrying handles
- Zip fasten

SET265	
Inner Qty: 4 / Outer Qty: 48	



TWIN PACK COOLER BLOCKS

These reusable cooler blocks will keep your food and beverages chilled for hours when placed in coolbags. Ideal for picnics and long journeys. Place in the freezer overnight and they're ready for use the following morning.

- Packaging: Shrink wrapped
- Packaging: Display unit
- Reusable ice blocks
- Food safe liquid inside
- 2x 200ml
- Great for picnic bags and coolers

711004D	
Inner Qty: 6 / Outer Qty: 48	



TABLE CLOTH HOLDERS

A simple yet effective way to secure your tablecloth on windy days with this set of 6 clear plastic clips. The spring loaded clips will fit tables up to a maximum of 3.5cm thick. The table cloth clips are easy to install and take off. Simply slide them on and the clips will self-adjust to hold tablecloths tightly in place.

- Packaging: Packaging: Blister card
- Set of 6
- Spring loaded
- Self adjusting
- Easy to use
- Maximum opening 3,5cm

660013	
Inner Qty: 24 / Outer Qty: 72	



Large Round Washing Up Bowl

- Packaging: Card wrap
- Collapsible design for convenient storage
- Made from durable, easy clean materials
- Size: 37cm (diameter) x 14cm (height)
- Folds down to 4.5cm depth
- Capacity: 7 litre

BLACK	BLUE	LIME GREEN
666055	666024	666025
Inner Qty: 4 / Outer Qty: 12		



Large Rectangular Washing Up Bowl

- Packaging: Card wrap
- Collapsible design for convenient storage
- Made from durable, easy clean materials
- Size: 37cm x 28cm x 12cm
- Folds down to 6cm depth
- Capacity: 7 litre

BLACK	BLUE	LIME GREEN
666053	666014	666013
Inner Qty: 6 / Outer Qty: 24		



Dish Drainer with Draining System

- Packaging: Card wrap
- Dish rack with swivel spout draining system
- Collapsible design for convenient storage
- Made from durable, easy clean materials
- Size: 37cm x 31cm x 12.5cm
- Folds down to 6cm depth

BLACK	BLUE	LIME GREEN
666063	666042	666043



Dish Drainer with Inserts

- Packaging: Colour box
- Dish rack with adjustable, removable dividers
- Collapsible design for convenient storage
- Made from durable, easy clean materials
- Size: 44.5cm x 33cm x 11cm

BLACK	BLUE	LIME GREEN
666059	666058	666052



Colander

- Packaging: Card wrap
- Collapsible design for convenient storage
- Made from durable, easy clean materials
- Size: 36.5cm (width) x 23cm (diameter) x 9cm (height)
- Folds down to 4.5cm depth

BLACK	BLUE	LIME GREEN
		
666056	666062	666061
		
Inner Qty: 6 / Outer Qty: 24		



3 Piece Bowl Set

- Packaging: Colour box
- Stackable storage bowls with lids
- Set of 3
- Collapsible design for convenient storage
- Made from durable, easy clean materials
- 0.5L ~ 13 x 6cm
- 0.8L ~ 16 x 7.5cm
- 1.2L ~ 19 x 8.5cm
- Folds down to 4.5cm depth

BLACK	BLUE	LIME GREEN
		
666060	666066	666065
		
Inner Qty: 8 / Outer Qty: 48		



Folding Basket

- Packaging: Card wrap
- Collapsible design for convenient storage
- Made from durable, easy clean materials
- Size: 38cm x 28.5cm x 16cm
- Capacity: 8.5 litres
- Can be used as a washing bowl when camping, for storing cleaning products or as a shopping basket.

BLACK	BLUE	LIME GREEN
		
666057	666034B	666034G
		



MyBento

Reusable Collection



REFILL
NOT LANDFILL



Did you know...

The UK fails to recycle **16 million** single-use bottles **everyday.**



On-the-go lifestyles require easily disposable products, such as single-use drinks bottles to keep us hydrated, but the accumulation of these products has led to increasing amounts of plastic pollution.

As plastic is composed of major toxic pollutants, it has the potential to leach harmful chemicals into liquids, which can be harmful when consumed and damaging to the environment.

Stay hydrated, protect the Earth's resources and invest in a reusable MyBento water bottle.

MyBento bottles encourage you to stay hydrated throughout the day. The reusable bottle range lets you fill up on the go, anytime, anywhere! Fill and refill with your favourite hot and cold beverages - not just water!



=

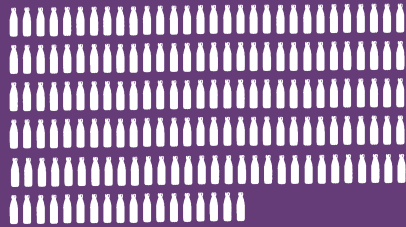

One MyBento bottle is equal to
150 single-use plastic bottles.

Re-use and refill

Stylish and durable, designed for longevity. MyBento bottles are easy to clean and ensure a fresh taste every time you refill.

Purse-friendly

Keep drinks at hand with MyBento; the ideal travel companion. Featuring a leak proof lid and sweat proof design, no spillage or mess guaranteed!

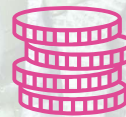

Single-use plastic water bottles cost the consumer 2000 times more than tap water.



Most single-use plastic bottles are non biodegradable and commonly end up in landfill and oceans.



Plastics release toxic chemicals as they decompose, causing pollution and threatening wildlife and sealife.

Eco-friendly



Made from BPA free borosilicate glass and tritan plastic - both recyclable materials which help protect the environment.

MyBento pop cup

Designed and manufactured to offer a more environmentally friendly, sustainable alternative to single-use plastic bottles and hot drinks cups.

Take your collapsible, reusable travel cup with you, wherever you go!

For hot and cold drinks

Collapsible!



Its clever space-saving design means that once your drink is finished, the cup can be collapsed down into a leakproof disc, taking up a fraction of space so that you can enjoy your favourite drinks while on the move.

Simply pop the base out and fill the cup with any hot or cold drink, slip on the heat resistant sleeve and go.



grande

450ml/16oz

The "Grande" cup has a 450ml capacity, equivalent to leading brands "Large" coffee cup. It is a collapsible travel mug with a screw-on drinking lid with stopper to prevent accidental spills, and a removable heat resistant sleeve so the cup can be held comfortably when filled with hot drinks.

Collapsible!



450ml / 16oz



grande Pop Cup in Coloured Box

- Packaging: Coloured Box
- Capacity: 450ml
- Collapses down to a disc (5cm folded height)
- 8.5cm diameter
- Spill proof lid
- Easy clean - top rack dishwasher safe
- Eco friendly - BPA free silicone
- Available in black, berry and light grey

Black	Raspberry	Light Grey
663070	663071	663072
5 035288 155086 >		
5 035288 155079 >		
5 035288 155062 >		
Inner Qty:6 / Outer Qty: 48		



grande Pop Cup on Clip Strip

- Packaging: Clip Strip
- Capacity: 450ml
- Collapses down to a disc (5cm folded height)
- 8.5cm diameter
- Spill proof lid
- Easy clean - top rack dishwasher safe
- Made from eco friendly BPA-free silicone
- 3 Assorted colours: black, berry and light grey

3 Assorted colours
663069C
5 035288 155055 >
Inner Qty:6 Outer Qty: 48



285ml Pack Away Wine Glasses

To use: Rotate the glasses to separate. Remove the lanyard clip and twist each base into the clear upper section to form the complete wine glass

- Packaging: Coloured Box
- Twin pack
- Capacity: 10oz / 285ml
- Base folds in to cup to save storage space
- Made from durable, easy clean materials
- Lanyard attachment
- Dishwasher safe* (*top shelf only)
- 3 Assorted colours: black, blue and lime green



3 Assorted colours
663088
5 035288 137860 >
Inner Qty:12 Outer Qty: 48

MyBento^{PURE} Glass Bottles



High Quality BOROSILICATE GLASS

A durable, transparent, wide-mouthed bottle made from high quality borosilicate glass.

Borosilicate glass is resistant to heat, harsh chemicals and corrosion. Borosilicate glass has a much higher melting point than ordinary glass and is also resistant to thermal shock, meaning this bottle can withstand sudden changes in temperature without expanding or shattering.



Fill with Hot & Cold Drinks

Fill up on your favourite beverages and stay hydrated throughout the day. Suitable for hot or cold drinks - not just water!



Borosilicate glass is hypoallergenic, lead-free and BPA-free.



Unlike single-use plastic bottles, MyBento bottles do not leach harmful toxins into liquids.

MyBento PURE glass bottles are scratch resistant and dishwasher safe*, ensuring that your favourite drinks bottle stays looking stylish, even after months of use.

*Bottle only



The "Refill, Not Landfill" campaign helps consumers become more aware of the impact single-use plastics have on the environment and our oceans, encouraging them to make positive changes to their own hydration habits by investing in a sustainable, reusable MyBento bottle.

MyBento^{PURE} Glass Bottles



50p
Donation



Glass Eco Bottle with Neoprene Cover

This reusable bottle features a protective neoprene sleeve that helps to retain the temperature of drinks for fulfilling refreshments wherever you go. Made from borosilicate glass that is shatter proof and resistant to temperature change.

- Reusable glass bottle
- BPA-free borosilicate glass
- Removable neoprene sleeve
- Plastic lid with silicone strap
- For hot and cold drinks
- 3 Assorted colours: peppermint, slate grey, rose pink
- Capacity: 550ml

3 Assorted colours
697004

5 035288 141775 >
Inner Qty: 6 Outer Qty: 24



Glass Eco Bottle with Sports Lid & Silicone Cover

Stay healthy and hydrated with the MyBento glass bottle. Purse-friendly and safe for re-use, the glass construction ensures fresh tasting water without contamination from the toxins found in plastic bottled water. The compact design features an easy-grip silicone sleeve, carry handle screw lid and a drinking straw. Save money and the Earth's resources by investing in an economical, reusable and recyclable MyBento bottle.

- Reusable glass bottle
- BPA-free borosilicate glass
- Carry handle screw lid
- Easy grip silicone cover
- 3 Assorted colours: peppermint, slate grey, amethyst
- Capacity: 550ml

3 Assorted colours
697003

5 035288 141768 >
Inner Qty: 6 Outer Qty: 24



50p
Donation

£1
Donation

Fruit Fusion!

Fruit Fusion Infuser Bottle

The MyBento Fruit infusion bottle includes a screw on lid with straw and a base compartment to store your favourite fruit.

Fill with your favourite fruit, add water and enjoy a healthy fruit fusion drink in seconds!

- Packaging: Colour Box
- Capacity: 750ml
- BPA free construction
- Integral folding straw
- Base compartment with fruit squeezer
- Screw on lid with loop for easy carrying
- 3 Assorted colours



Twist off the base container and squeeze your chosen fruit onto the integral base juicer. Leave fruit in place and replace the base container.

Remove the cap and fill the infuser with water, tightly refit the cap and you're good to go!

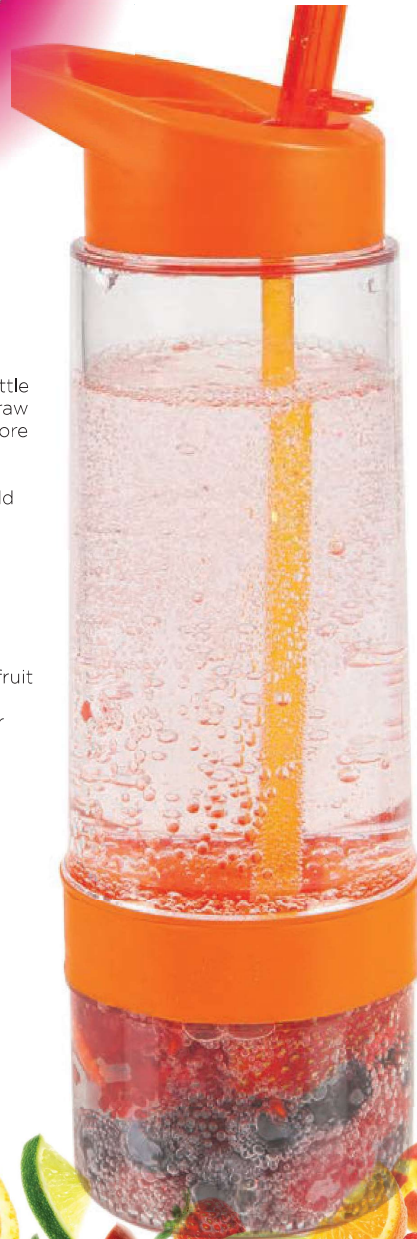

The liquid mixes with the freshly made fruit to produce a healthy, invigorating drink.

The longer you leave the drink to infuse,

3 Assorted colours

696008



5 035288 107979 >

Inner Qty: 12
Outer Qty: 48



Water Bottle with Filter & Carabiner

Stay healthy and hydrated with this reusable filter bottle. It filters water as you drink through the ingenious built-in carbon filter. Chlorine is removed from ordinary tap water for an odour free, purified taste. The water bottles filter will last the equivalent of approx 300 bottles of water.

- Internal carbon filter to purify tap water
- Includes carabiner
- Tough PET bottle, BPA free
- Leakproof drinking spout
- Extra replacement filters available
- (696013) 4 Assorted colours
- (696024) 2 Assorted colours

SPECIAL OFFER! Buy one carton of filter bottles and get a carton of filters <u>free</u> .	
550ml bottles	1 Litre bottles
696013	696024
Inner Qty: 12 / Outer Qty: 48	
2 pack of Replacement Filters (4 assorted colours)	
550ml	1 Litre
696014	696014A
Inner Qty: 12 / Outer Qty: 48	



Sports Filter Bottle

This BPA-free bottle has a generous 700ml capacity and replaceable filter which removes organic contaminants from water. Complete with a screw on lid, fold up straw and carrying handle. Perfect for everyday use and sports.

- Capacity: 700ml
- 1 active carbon filter included
- Carbon filter purifies tap water
- Leakproof folding straw
- Extra replacement filters available
- 4 Assorted colours

SPECIAL OFFER! Buy one carton of filter bottles and get a carton of filters <u>free</u> .	
700ml bottle	
696032	
Inner Qty: 12 / Outer Qty: 48	



Designed in the UK

LIGHTING

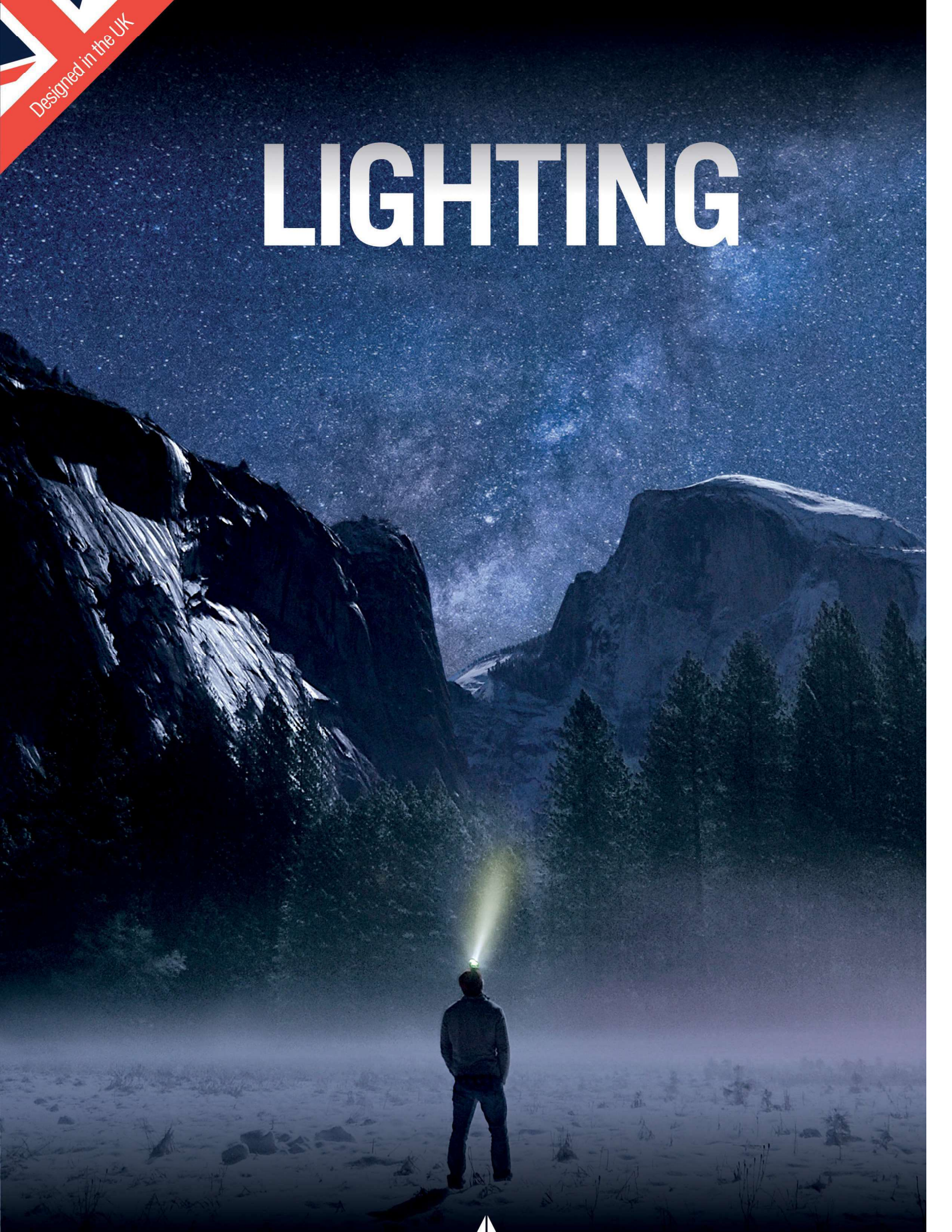

PROLITES

The lighting featured in the Prolites brand is aimed at any user that needs value for money effective light in any situation, whether that's at home or outdoors.

Being battery operated, they can be used anywhere and you are not restricted by cables that limit the environment they can be operated in. Designed to be energy efficient and low cost to run, the Prolites LED range includes handheld torches, headtorches, lanterns and multi-use LED lights or sets.



Prolites packaging and artwork is designed with the consumer in mind, offering easy to display counter units, to free standing colour boxes, all with key information about battery types, lumen counts, battery burn times and other key product features, empowering your customers to make a choice about which product to buy.

8HR

9W

600

Ultra
Light

3xAA
Batteries

HOW TO CHOOSE YOUR LIGHTING

LUMENS

Lumens (lm) are the measurement of a lighting products brightness output and measured by the amount of light visible to the human eye.

On our Stormforce range of products, the Lumen counts are included on the packaging, enabling quick decision making over how powerful the light will be.

120
LUMENS

Example of icon displayed on packaging.



BEAM RANGE

This is the maximum distance from a torches beam that is visible when it is on its highest light setting.

We give a number of metres on our packaging for beam distance making it easier to select the right product for the given task or use.

With the advancement of LED technology, some lights in the Stormforce range can be seen in a clean line of sight for up to 5 miles.

8M
RANGE

Example of icon displayed on packaging.

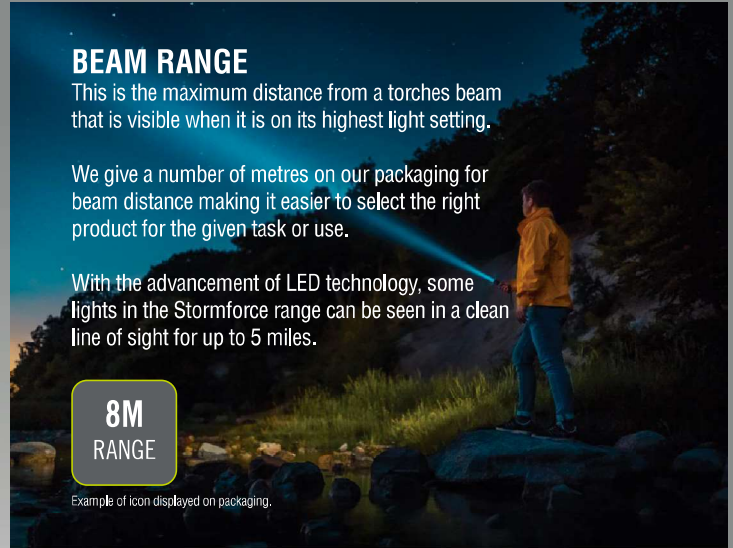

BURN TIME

We calculate how many continuous usage hours each of our lighting products deliver on one set of batteries. Whether Prolites or Stormforce, we add this information to our packaging, another way for customers to easily identify the best option that suits their individual needs.

The hour rating is based on the products highest light output setting, so would be greatly extended when using the power saving modes where applicable. Unless stated otherwise, we include batteries to ensure the lights can be used straight away. We do not include Alkaline batteries (unless stated) as a lot of our retail customers sell these separately.

Summit always recommends that consumers use Alkaline batteries with our products because the light output can be greater and the battery burn time is greatly extended.

6HR
BURN TIME

Example of icon displayed on packaging.

LEDs use **90% less power** than incandescent bulbs and **60% less power** than CFL bulbs

LIGHT EMITTING DIODES (LEDs)

LEDs are far greener than traditional lighting, helping both domestic and commercial users to lower their carbon footprint, whilst delivering much better light performance than incandescent and CFL bulbs (the first energy saving light bulb). On average, LEDs last much longer and on average can last more than 15 years.

LEDs do not have any mercury content and they produce on average 4 tons less CO2 than incandescent light bulbs, ensuring you can be confident you have the greenest and least pollutant form of light.

Summit LEDs are designed to last in excess of 100 thousand hours, that is 10x the expected life of an old energy saving light bulb (CFL).

LEDs are impact resistant, so when housed in torches, headtorches and lanterns, they make very compact and durable lighting solutions that perform outdoors and in tough environments.

INGRESS PROTECTION 'IP' RATING

'IP' ratings are given to products that give protection against solids (like dust) and liquids (like water) that could have an effect on the use of a product in extreme outdoor conditions, like torrential rain or dust storm.

Summit Prolites and Stormforce products are designed and manufactured to give protection in extreme conditions to the standard of IP54.

IP54
RATED

Example of icon displayed on packaging.

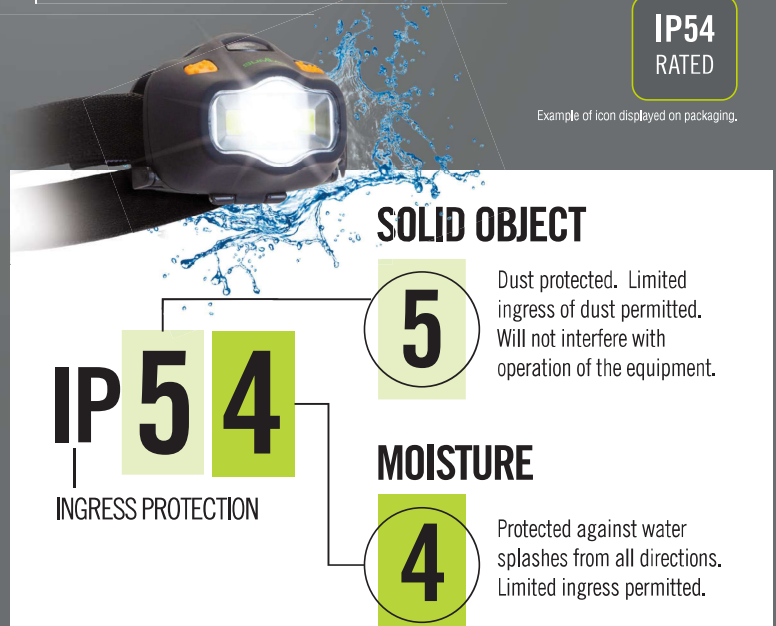

CONTENTS

PROLITES

- 08 LED Torches
- 10 LED Headlights
- 12 LED Lanterns
- 14 Multi-use Lighting & Sets

PROLITES

From page
07



STORMFORCE

From page

17



STORMFORCE

- 18 Flashlights
- 20 Headlights
- 25 Lanterns
- 27 Multi-use Lighting & Sets





LED ALUMINIUM TORCH 4 ASST COLOURS

9
LEDs

25
LUMENS

3XAAA
BATTERIES

Item Number 841019

This durable aluminium Prolite torch is a great everyday essential for the home, camping trips and travelling. Complete with 9 LEDs and batteries, this torch is available in 4 assorted colours.

- Inner Qty: 16
- Outer Qty: 96
- Packaging: Shelf Display Tray
- Battery Information: 3 x AAA included
- 9 ultra-bright LEDs
- 25 Lumens
- Aluminium casing
- Size: 2.5 x 9cm
- Wrist lanyard
- 4 Assorted colours: orange, purple, black and silver



FOCUS BEAM TORCH

1W
LED

65
LUMENS

FOCUS
BEAM

3XAAA
BATTERIES

Item Number 841008

High power LED torch with an adjustable focus beam, twist the head of the torch to alter the focus strength. The bulb inside will move closer to the magnified lens when zoomed in. Switch to energy saving mode via on/off button with high, medium and SOS light modes.

This torch has a rubberised body and the screw on end cap with on/off button acting as a battery cover.

- Inner Qty: 12
- Outer Qty: 48
- Packaging: Shelf Display Tray
- Battery Information: 3 x AAA included
- 1 Watt LED torch
- 65 Lumens
- Rubberised casing
- Twist to change light from focus to flood beam
- Wrist lanyard
- Colour: Black





MICROLITE HEADLIGHT

10
LUMENS

12HR
BURN TIME

10M
RANGE

BATTERIES
INCLUDED

IP54
RATED

Item Number 098/016

This lightweight single superbright LED headlight features an elasticated and adjustable head strap, it also comes with a clip so that it can be attached to different surfaces or clothing for an alternative hands-free light source.

- Inner Qty: 5
- Outer Qty: 50
- Packaging: Clam Shell
- Packaging: Shelf Display
- Battery Requirements: 2 x CR2032 (included)
- LED head torch
- Elasticated, adjustable head strap
- Twist on/off function



ULTRALITE HEADLIGHT

3
LEDs

12
LUMENS

8HR
BURN TIME

10M
RANGE

BATTERIES
INCLUDED

IP54
RATED

Item Number 843008

The Ultralite Headlights compact design features crafted optics that improve the light output and distance it can illuminate ahead.

- Inner Qty: 6
- Outer Qty: 48
- Packaging: Clam Shell
- Packaging: Shelf Display
- Battery Requirements: 2 x CR2032 (included)
- Ultra lightweight headtorch
- 3 Ultra bright LEDs for flood light
- Durable casing
- Elasticated head strap



NIGHTSTORM 600 HEADLIGHT

6
LEDs

25
LUMENS

12HR
BURN TIME

10M
RANGE

ADJUSTABLE

3XAAA
BATTERIES

IP54
RATED

Item Number 098/028

The Nightstorm 600 headlight has been designed to deliver a wide range of light options, ranging from 2 superbright LEDs that give forward directional light beams, then a full 4 LEDs that add side angle floodlight, giving a wide area of light nearer the user. Finally the third feature is a further 2 superbright red LEDs that cover vision at night and anti-glare against surfaces like water, ideal when fishing or trying to read maps in dark conditions. These lighting modes are activated via repeated pressing of the on/off switch.

- Inner Qty: 4
- Outer Qty: 36
- Packaging: Clam Shell
- Packaging: Shelf Display
- Battery Information: 3 x AAA (included)
- 4 Light Modes
- 4 White superbright LEDs
- 2 Red superbright LEDs for night vision
- Soft feel case backing for comfort
- Elasticated adjustable head strap
- Adjustable light angle



3W COB HEADLIGHT

3W
COB LED

200
LUMENS

8HR
BURN TIME

80M
RANGE

ADJUSTABLE

LIGHT
CONTROL

3XAAA
BATTERIES

IP54
RATED

Item Number 843012

The COB headlight features an extremely bright 3W COB style LED, delivering over 200 lumens of floodlight style output. It has adjustable angle to direct the light, as well as an elasticated, adjustable headstrap to ensure a comfortable fit. We have included 3 energy saving light modes due to the power of this headlight, they are 100%, 50% and emergency flashing mode. This product is ideal for any user needing a large, wide amount of light immediately around them. The headlight unit has been constructed with a rubberised casing and is rated IP54 to ensure the electronics stay dry and dust free when in use. The body design incorporates an on/off switch either side of the unit to ensure you can easily operate it whether you are left or right handed.

- Inner Qty: 4
- Outer Qty: 48
- Packaging: Clam Shell
- Packaging: Shelf Display
- Battery Requirements: 3x AAA (included)
- 3 Watt COB LED
- Elasticated headstrap
- 3 Light Modes



Collapsible COB LED Lanterns

SPACE-SAVING

The lantern's space-saving design enables it to collapse into itself when not in use, taking up minimal storage space and protecting the lantern's lens.

9W
COB LED

8HR
BURN TIME

IP54
RATED

*Micro Lantern
6W COB LED

PORTABLE

Compact and lightweight with folding stainless steel handles to provide easy carrying and hanging.

360° ILLUMINATION

COB (chip on board) LEDs have been engineered to give a broad spectrum of light to illuminate an area around the lantern.



MATT BLACK RUBBER FINISH

Internal battery compartment features a screw cap base to increase the lantern's water resistance when used in wet conditions.

Pull up for on

Push down for off



QUICK & EASY OPERATION

Simply lift the lantern by the handles to turn on, or push down to turn the light off.



MICRO

6W
COB LED

300
LUMENS

3x AAA Batteries

Batteries included



MIDI

600
LUMENS

3x AA Batteries

Batteries included



FAMILY

600
LUMENS

4x AA Batteries

Batteries included

MICRO

842056



5 035288 153556 >

MIDI

842043



5 035288 136481 >

FAMILY

842057



5 035288 153563 >

Inner Qty: 6 / Outer Qty: 24



COB Lantern & Torch

BATTERY OPERATED

150
LUMENS

8HR
BURN TIME

8M
RANGE

3XAAA
BATTERIES

IP54
RATED



A versatile lighting solution, powerful COB lantern torch & spotlight



Torch configuration



Powerful magnet



Fold away hanging hook for lantern configuration

A new innovation of the Orb light, we have integrated a new superbright COB LED in to the light giving off 150 lumens, the light is diffused by the opaque 'bulb' shape housing in Lantern mode.

Then a re-design of the base has allowed us to fit a rotating light fixture, that when you swivel the light, it turns in to a torch/spotlight.

With the new flat base, it will stand for handsfree light, hang via the foldaway hook and be handheld in the torch mode.

- Packaging: Colour Box
- Battery Information: 3 x AAA (included)
- COB lantern, torch & spotlight
- Foldaway hook for lantern configuration
- Powerful magnet on base
- ON/OFF push button

842047



5 035288 140921 >

Inner Qty: 9



Designed in the UK

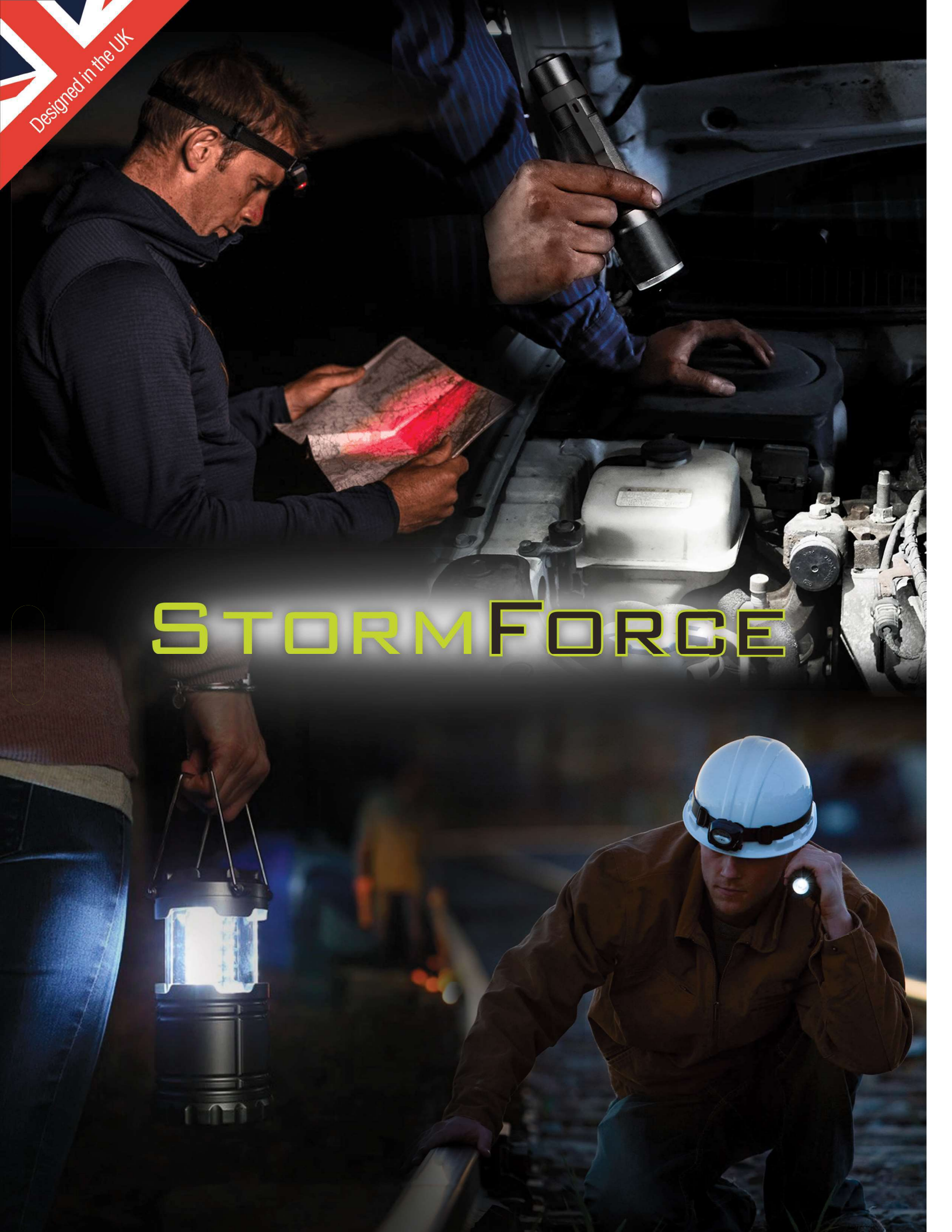

STORMFORCE

10W TACTICAL RECHARGEABLE FLASHLIGHT

EIGER
TACTICAL



Mini USB charging lead supplied!



* Approx. Runtime:
Ultrabright: 2.5 hours / Bright: 4 hours

10W
CREE LED

720
LUMENS

4
HOURS
ILLUMINATION

500M
RANGE

3
LIGHT MODES

IP54
RATED

USB rechargeable (USB charging lead included), the Tactical Flashlight has been designed with and encases a 10 Watt CREE LED, emitting over 700 lumens on its full power setting. The flashlight has different light modes to optimise power and extend battery burn times, with 75%, 50% power and flashing for emergency signalling. On its brightest setting you can depend on 2.5 hours of continuous light, then 4+ hours of continuous light on a single charge when on 50% power setting. The lightweight aluminium construction, charging port cover and battery compartment seals, mean that you can depend on the flashlight in extreme weather conditions and is rated IP54 weatherproof.

- Packaging: Colour box
- Battery Information: Rechargeable 2000MAH battery
- 10 Watt CREE LED
- 3 light modes: 100% / 50% / Flashing
- USB rechargeable cable included
- Aluminium casing
- Wrist lanyard

841064



5 035288 144608 >

Inner Qty: 6
Outer Qty: 24

3W NIGHT VISION HEAD LIGHT

RECHARGEABLE

EIGER
TACTICAL

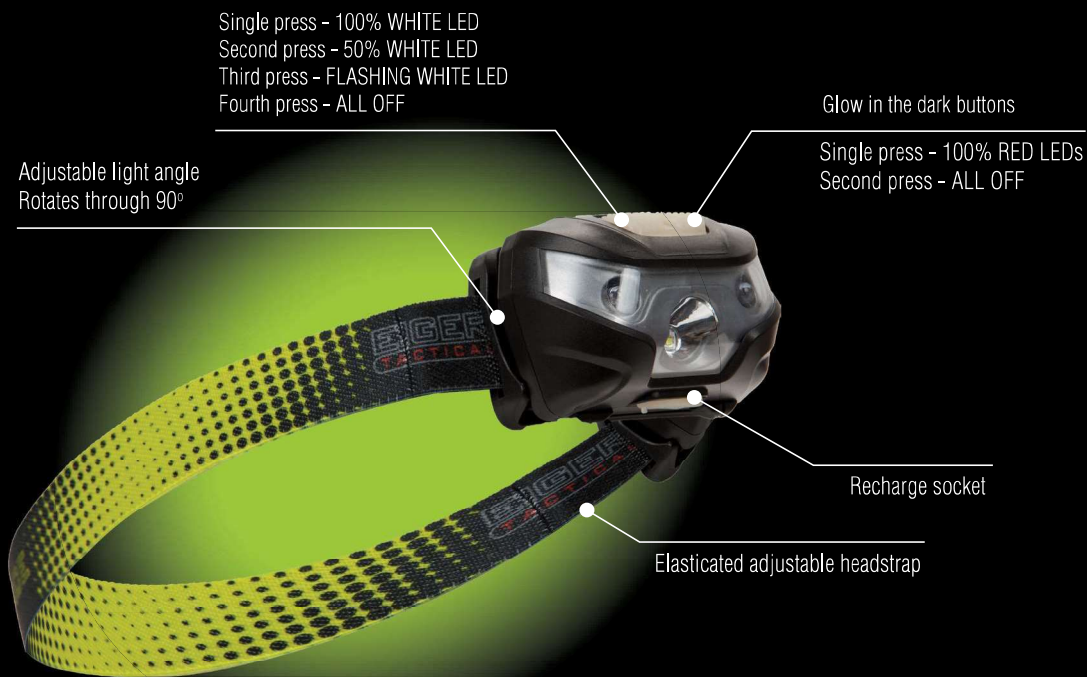

3W
HI-POWER LED

200
LUMENS

3.5HR
BURN TIME

80M
RANGE

IP54
RATED



**Twin night light Red LED's
Helps with night vision!**



Simply plug in to recharge

USB Charging lead supplied. Charge for 3-4 hours before use.
Each charge will give up to 3.5 hours operation

The Storm Force 3 Watt LED Eiger headlight is rechargeable via the built-in mini USB socket. Featuring a 3 Watt hi-power white LED and twin red night light LED's. The 3 Watt Focus Beam mode on full power provides a 200 lumens output and 3.5 hour battery life. Complete with an elasticated headstrap and glow in the dark function buttons.

- Packaging: Colour Box
- 3 Watt LEDs
- Red night lights
- Rechargeable via USB port
- Includes micro USB cable
- Glow in the dark function buttons
- Adjustable elasticated headstrap

843013

5 035288 137129 >

Inner Qty: 6

30 SMD LED LANTERN

REMOTE CONTROL

EIGER
TACTICAL

SMD's are second generation LED's with higher light output over a wider arc making them ideal for area illumination



30
SMD LEDs

150
LUMENS

35HR
BURN TIME

3X'D'
BATTERIES

HANDLE
& HOOK



Remote control
Point at the lantern to turn on/off

REMOTE

20M
RANGE

3XAAA
BATTERIES

The durable rubber finish of the lantern means it is resistant to knocks, accidental drops and is highly weather resistant. 30 SMD LEDs are encased in the light housing, with a diffuser for a more balanced light output. Operated either manually via the on/off push button, or via the remote FOB with a workable distance of 20 metres+. The lantern will emit 150 lumens of light and work continuously on one set of batteries for 35 hours.

- Packaging: Colour Box
- Battery Information: 3 x D (not included)
- Remote Battery Information: 3 x AAA (not included)
- 30 SMD LEDs
- Remote control included with 20 metre range
- Integral handle for carrying and hanging
- 150 Lumens output with a 35 hour burn time
- Remote range: 20 metres

842051



5 035288 142710 >

Inner Qty: 6
Outer Qty: 24